

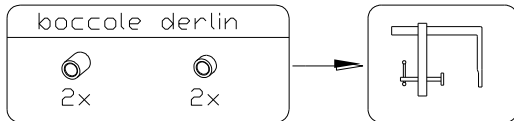

PINZA FORESTALE PER TRONCHI

IT 1050

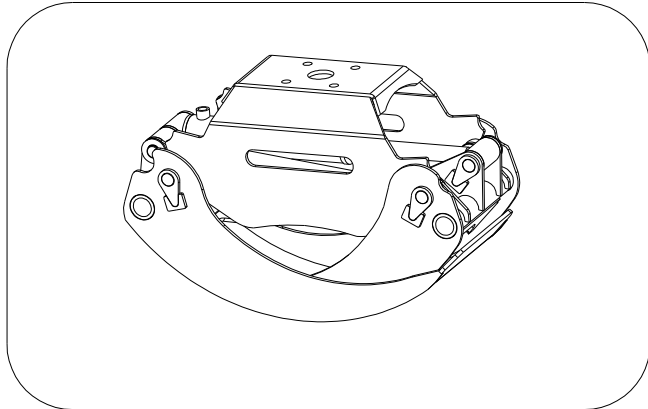

1

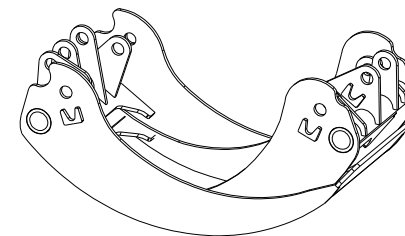
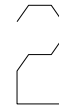
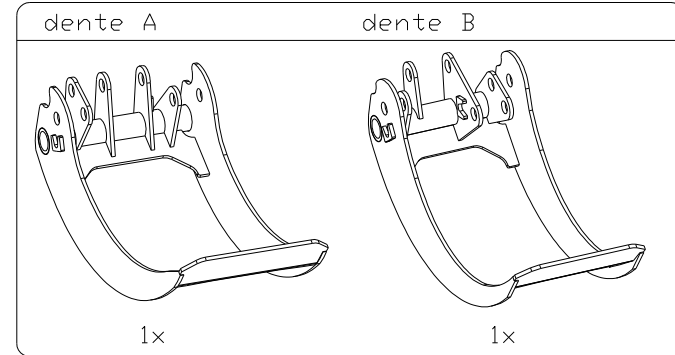
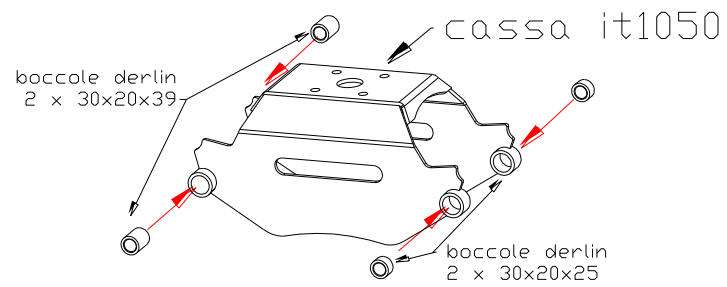

3

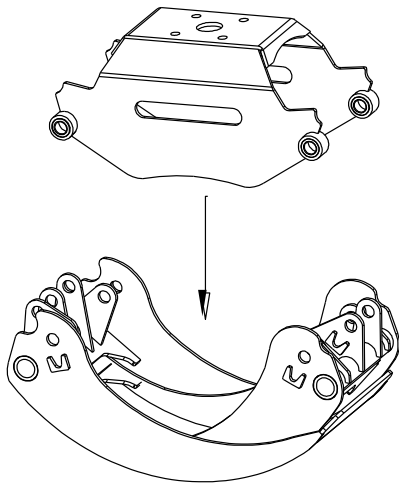

4

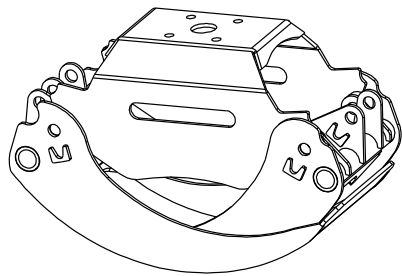

perni filettati ghiera M17x1



2x53



2x67



4x

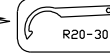

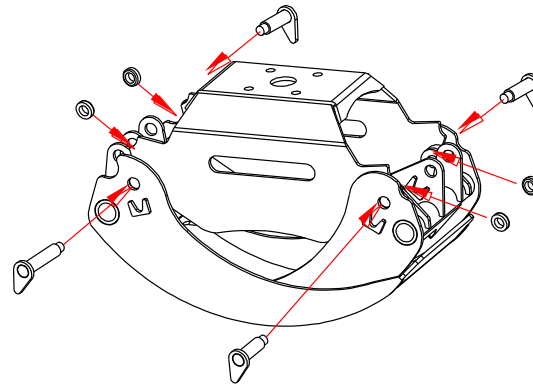

R20-30

5



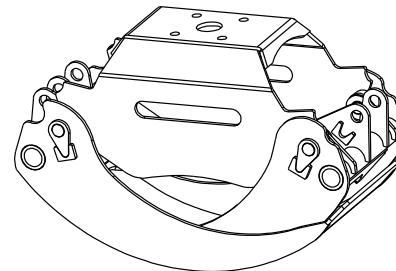

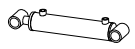

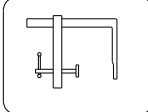
6

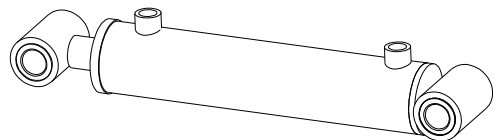
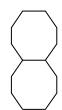
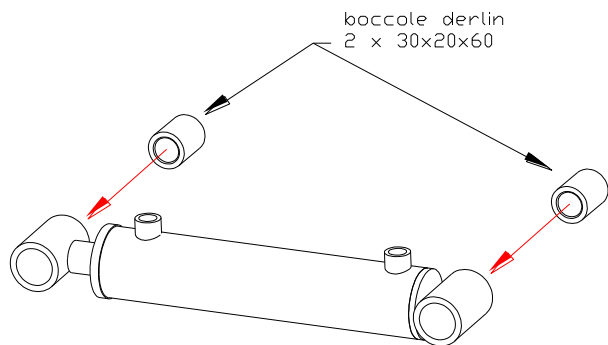

cilindro	boccole derlin	
		
1x	2x	

7



perni filettati	ghiera M17x1	
		
1x88	1x139	1x

9

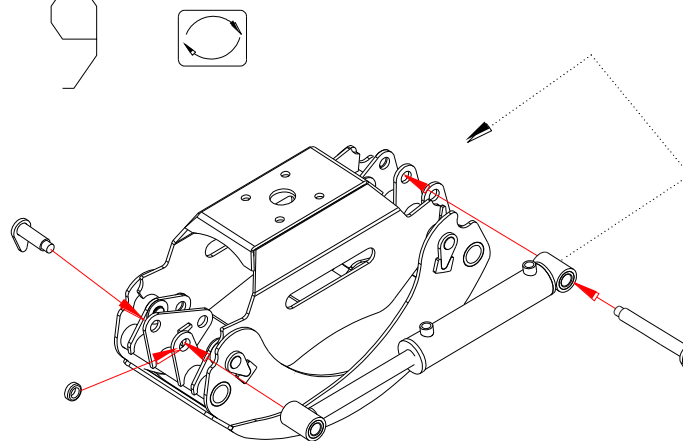

10

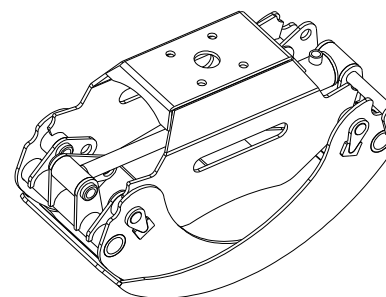

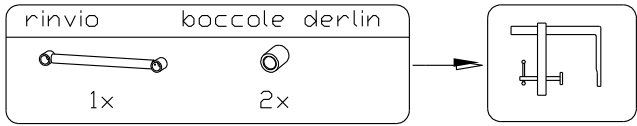

11

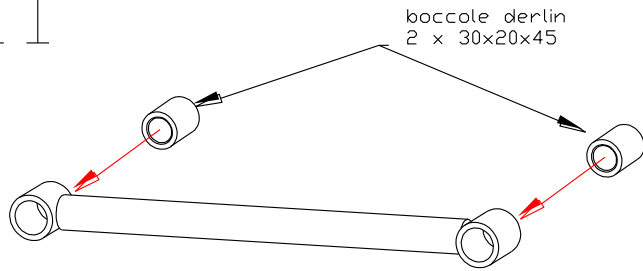

12

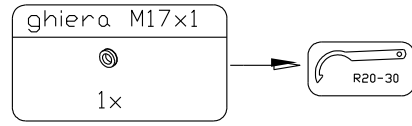
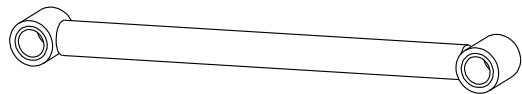

13

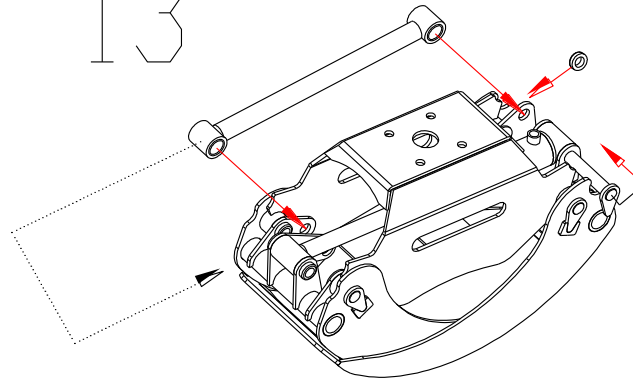

14

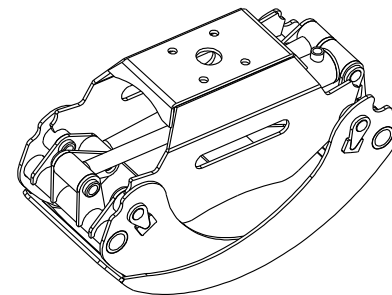

perno filettato ghiera M17x1



1x73



1x

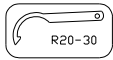

R20-30

15

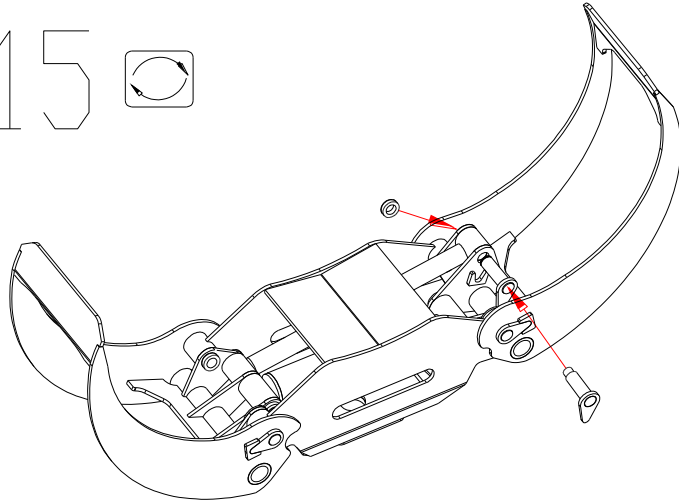

16

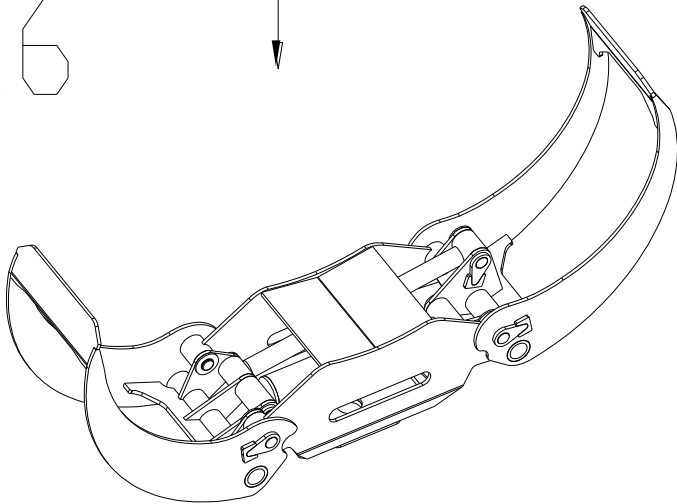

17

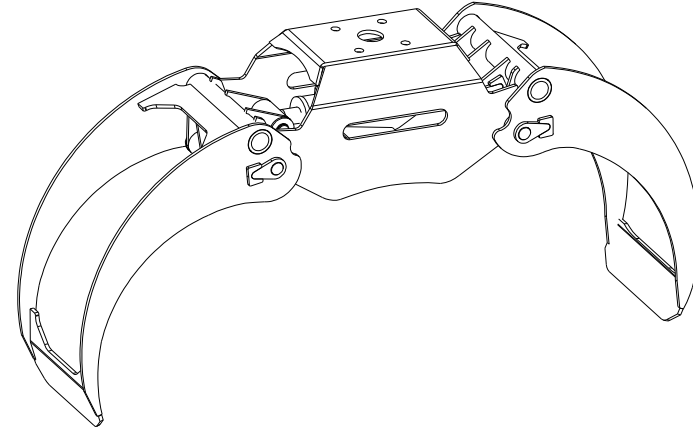

18

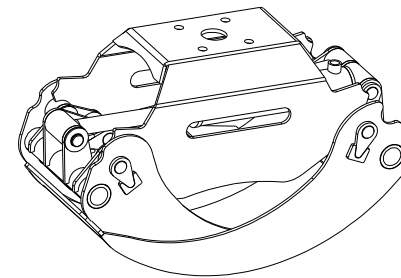

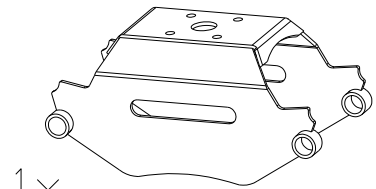

Cassa it1050New2018

1x



Rinvio it1050

1x

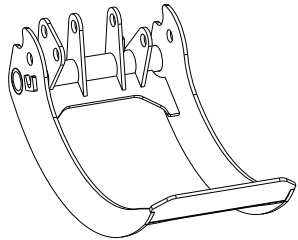

Dente A it1050

1x

2x



Boccola Derlin 30x20x39

2x



Boccola Derlin 30x20x25

2x



Boccola Derlin 30x20x45

2x



Boccola Derlin 30x20x60

2x



Perno 20x53

2x



Perno 20x67

1x



Perno 20x73

1x



Perno 20x88

1x



Perno 20x139

7x



Ghiera M17x1

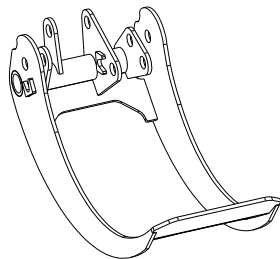

Dente B it1050

1x

Cilindro it1050

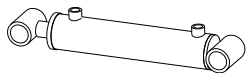

1x

